

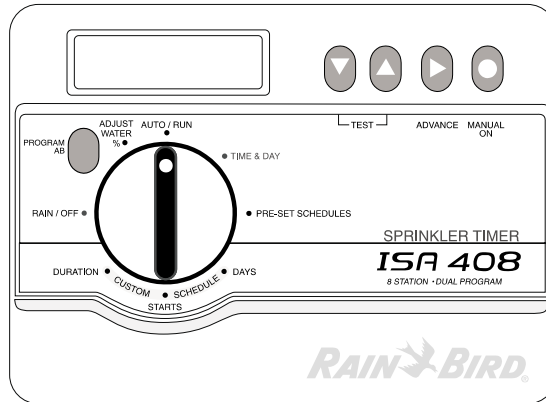

ISA 300 / 400 SPRINKLER TIMER
Installation, Programming, and Operation Guide



RAIN BIRD IRRIGATION CORPORATION

Technical Services: 800-247-3782 • <http://www.rainbird.com>

CONTENTS

INTRODUCTION 1

ISA Timer Features and Benefits	1
Timer Stations	2
ISA Timer Controls and Indicators	3

INSTALL TIMER 4

Select Location	4
Mount Timer	5
Install Battery	5
Connect Field Wiring	7
Select Proper Wire	7
Connect Valve Wires to Timer	7
If Using a Master Valve or Pump Start Relay	9
Connect Transformer	11

PROGRAM TIMER 13

Set Current Time and Day	14
Select a Program	15
Pre-Set Watering Schedules	16
Select a Pre-Set Schedule	17
Modify a Pre-Set Schedule	19
Set Schedule Watering Days or Watering Interval	19

Set Schedule Start Time(s)	21
Set Station Watering Duration (Run Times)	23
View Pre-Set Schedule Information	24

OPERATING THE TIMER 26

Turn the Timer On and Off	26
Run a System Test	27
Manually Run a Program or Single Station	29
Run Program(s) Manually	29
Run Station(s) Manually	30
Adjust Watering Percentage	32

WINTERIZING THE SYSTEM 33

TROUBLESHOOTING 34

INTRODUCTION

Thank you for purchasing a Rain Bird ISA 300 / 400 Series Sprinkler Timer. ISA timers provide simple programming and flexible watering schedules to meet almost any landscape's needs. These timers can be used with any 110 VAC / 60 Hz electrical outlet (240 VAC / 50 Hz for the international version).

This manual describes how to install, program, and operate your timer. Read this manual carefully and keep it in a handy place for future reference.

If you have any problems with your ISA Sprinkler Timer, please call the Rain Bird Technical Assistance hotline at 800-247-3782 before returning your timer for service. You may also be able to find information to help solve your problem on the Rain Bird web site: www.rainbird.com.

ISA Timer Features and Benefits

The ISA Sprinkler Timer is an electronic clock that controls when your sprinkler system turns on and how long the sprinklers run. The ISA timers offer several advanced features, including:

- Large LCD display and easy-to-use programming dial and buttons
- Six convenient pre-set watering schedules
- Two independent watering programs (ISA 400 models)
- Up to three watering start times per program
- Ability to control four, six, or eight watering stations (depending on model)
- Rain-Off feature can suspend watering and retain all programmed information

Timer Stations

Most sprinkler systems divide the yard into “stations” (also called “zones”). You can program each station to water for a different length of time, so the amount of water fits the different plant types, soil conditions, and sunny/shady areas in the yard.

Each station has an irrigation valve that runs several sprinklers. An electric signal from the timer opens

the first valve, which turns on the sprinklers connected to it. When these sprinklers have run for their programmed time, the timer closes the first valve and opens the second valve.

For example, the illustration below shows that station 1 is currently watering. When station 1 finishes, the timer will shut it off and start station 2. When station 2 finishes, station 3 begins, and so on.

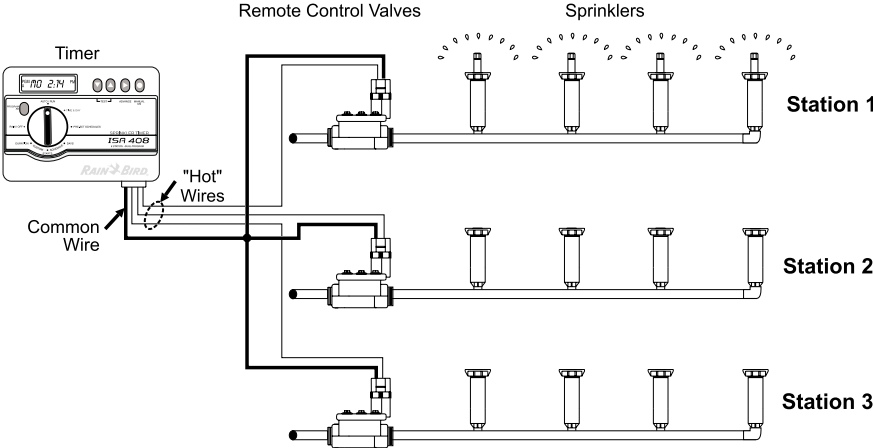

ISA Timer Controls and Indicators

This illustration shows the programming controls on the face of the ISA Sprinkler Timer. These controls include:

- ❶ “Manual On” button
- ❷ “Advance” button
- ❸ Up/ Down arrow buttons
- ❹ LCD display
- ❺ Programming dial
- ❻ “Program A/B” button

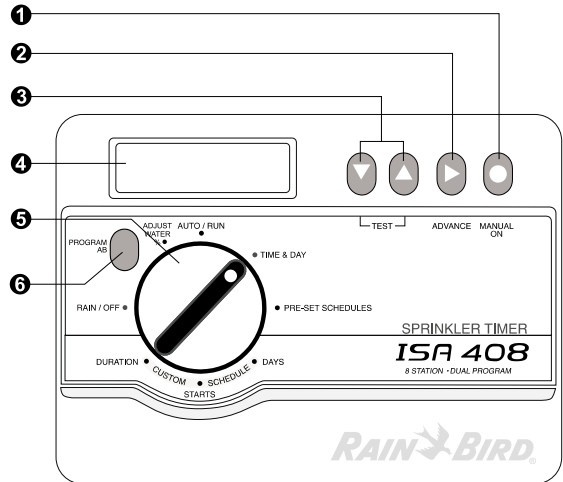

INSTALL TIMER

Before installing your ISA Sprinkler Timer, make sure you have the following tools and equipment:

- Phillips screwdriver
- Three #10 screws (1¼" / 32mm)
- 9-volt alkaline battery (not included)
- 18-gauge color-coded, multi-strand, direct-burial wire for wire runs of less than 800 feet. (For runs longer than 800 feet, use 14-gauge color-coded, multi-strand, direct-burial wire).
- Watertight wire splice connectors
- Plastic mounting anchors (may be required for plaster or masonry walls)

Select Location



NOTE: The ISA Timer is for INDOOR use only. If you must install it outdoors, use a water-resistant cabinet, such as the Rain Bird Model TC-2 Timer Cabinet. The TC-2 is a heavy-duty, weather-resistant plastic case that lets you convert any indoor-only timer to outdoor use.

Select a convenient indoor location within six feet (1,9 m) of a 120-volt AC electrical outlet (240-volt outlet for international 50 Hz models). The mounting location should be completely protected from moisture, direct sunlight, and freezing temperatures.

Mount Timer

- 1 Screw two #10 screws into the wall 4¾" (120 mm) apart. Leave ⅛" to ¼" (3,2 to 6,4 mm) of each screw head protruding from the wall. (Use plastic mounting anchors for plaster or masonry).
- 2 Place the two keyhole-shaped slots on the back of the timer over the screw heads. Then slide the timer securely down onto the screws.

OPTIONAL: To further secure the timer, remove the timer's lower access cover by gently pulling the cover off using the slots on the left and right sides of the timer. Then drive a third screw through the lower middle hole.

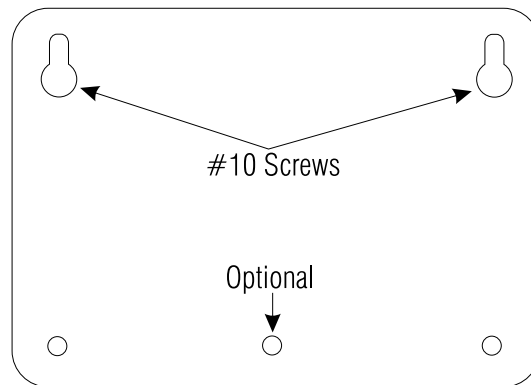

Install Battery

During a power outage, the battery preserves your programmed watering schedules. A newly installed battery will hold information for up to six hours if power goes out.



NOTES: The battery serves as memory back-up only. You can program the timer on battery power, but the system will not water without AC power.

Replace the battery once a year. If power outages occur frequently, you may need to change the battery more often.



NOTE: When replacing the battery, DO NOT unplug the transformer or you will lose all programmed information.

If the battery fails during a power outage, the timer will revert to its default watering program. The default program waters each station every day for 10 minutes, starting eight hours after AC power resumes. The default program will continue until you reprogram the timer.

- 1 To install the battery, remove the timer's lower access cover by gently prying out the cover at the slots on the left and right sides of the timer.
- 2 Connect the terminals of a 9-volt alkaline battery to the timer's two-wire battery clip. (**DO NOT** use a rechargeable battery). The display flashes "AC OFF" and "8:00 AM."
- 3 Replace the lower access cover, or connect field wiring as described in "Connect Field Wiring" on page 7.



CAUTION: DO NOT allow the battery to contact the timer's terminal strip.

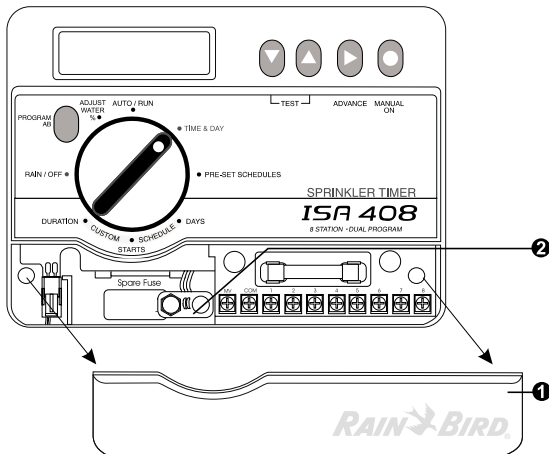

Connect Field Wiring

Select Proper Wire

For wire runs of less than 800 feet, use 18-gauge color-coded, multi-strand, direct burial wire. For longer runs, use 14-gauge wire of the same type.

Choose wire that has one strand for each valve in your system, plus one strand for the common wire. For example, use five-strand wire if you have four valves, seven-strand wire for six valves, etc.

Tape off spare wire strands for future system use or troubleshooting. Wire that is buried underground must have watertight connections and be code-approved for underground use. Avoid placing underground wire in places where it may be damaged by digging or other activities.

Connect Valve Wires to Timer

Each valve connects to the timer with two wires: a “hot wire” of its own, and a “common wire” that it shares with the other valves.



NOTE: The ISA Series Timers can be used with most hydroindexing valves. Please contact the valve manufacturer for more information.

- 1 Remove the timer's lower access cover by gently prying out the cover at the slots on the left and right sides of the timer.
- 2 Splice together one wire from each valve (usually the white strand) to create a single "common" wire. Connect the common wire to the terminal screw labeled "COM."



NOTE: Make sure all wire connections are tight and in firm contact with the terminal screws. Use watertight splice connectors to prevent corrosion and avoid short circuits.

- 3 Connect each valve "hot" wire to a numbered screw on the timer's terminal strip. Connect the wire from valve number 1 to terminal screw 1; connect the wire from valve 2 to terminal screw 2, and so on.



CAUTION: DO NOT connect more than one valve wire to each terminal screw. Wiring more than one valve to each terminal will damage the timer. Also, if you are using more than one timer, do not share "common" wires between them.

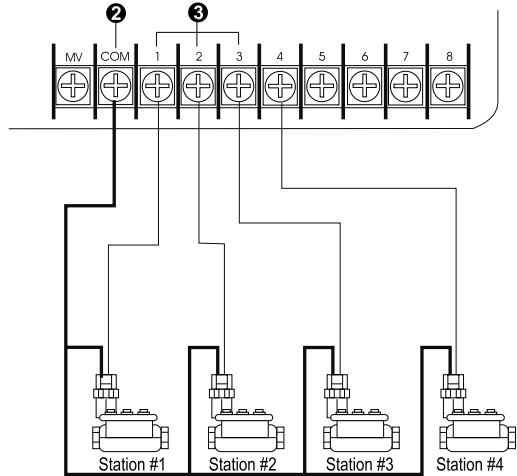
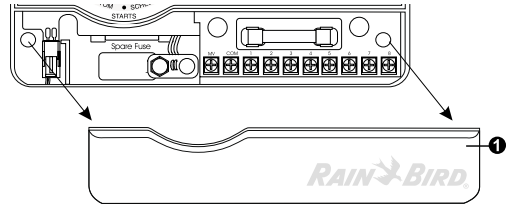

Station Valves

- 4 After connecting all valve wires, replace the timer's lower access cover.



NOTE: To save water and money, you can also install a rain sensor, such as Rain Bird's RS-1 Rain Shut Off. The RS-1 measures rainfall and prevents unnecessary watering.

If Using a Master Valve or Pump Start Relay

(Optional ISA 400 Series only)



NOTE: Complete this section only if you are using a pump start relay or a master valve (an automatic valve installed on the mainline pipe upstream from the station valves). The timer does not provide the main power for a pump.

ISA 400 Series Timers allow a master valve or pump start relay to operate whenever a valve is operating. Pumps are used in some places to draw water from a well or other source.

If you are activating a pump from the timer, you must also install a Pump Control Relay, such as Rain Bird's PCR-1. The PCR-1 offers solid-state reliability and can activate most 120- or 240-volt pump motors up to two horsepower.

- ❶ Connect the color-coded “hot” wire from the master valve or pump start relay to the timer terminal screw marked “MV.”
- ❷ Connect the common wire from the master valve / pump start relay to the common wire coming from the station valves. This wire connects to the timer terminal screw marked “COM.”

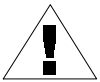

NOTE: Make sure that the total draw of the master valve or pump start relay plus the draw of the valve does not exceed 0.650 Amps at 24 VAC, 60 Hz.

- ❸ To avoid possible pump damage, connect a short “jumper” wire from any unused station terminal(s) to the nearest terminal screw in use. For example, if you have an eight-station timer with only four stations in use, jumper stations five through eight to the nearest active station (four).

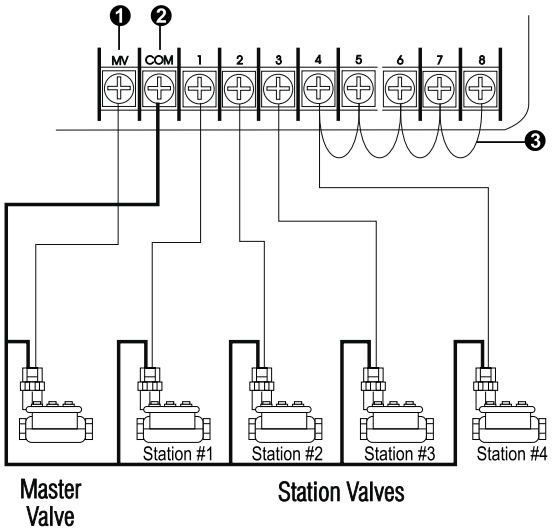

Connect Transformer

After installing the battery and connecting the field wires, you are ready to connect the timer's transformer.



CAUTION: DO NOT plug in the transformer until you have completed and checked all wiring connections. Also, do not attempt to link two or more timers together with a single transformer.

- ❶ Remove the timer's lower access cover by gently pulling the lower access cover off using the slots on the left and right sides of the timer.
- ❷ Turn the dial to **RAIN / OFF**.
- ❸ Plug the pigtail connector (located on the end of the transformer wire) into the two-prong connector to the left of the battery compartment.

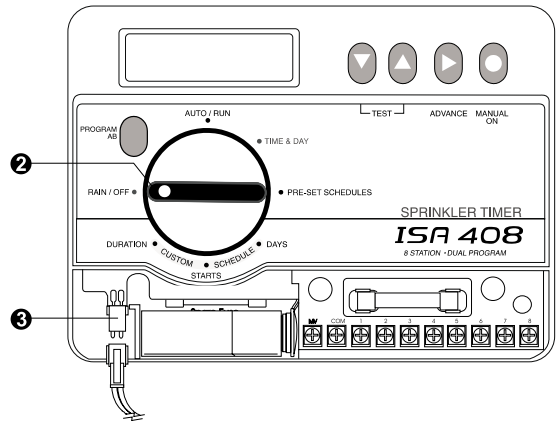
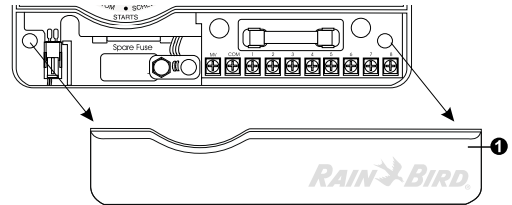

- 4 Plug the transformer into an electrical outlet. The display flashes the hour digits and "OFF."



NOTE: If the display does not come on, verify that the battery is new and securely connected.

- 5 Turn the dial to **AUTO / RUN**.

This completes the installation and wiring process. You are now ready to program your timer.

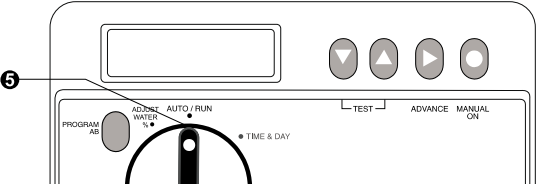
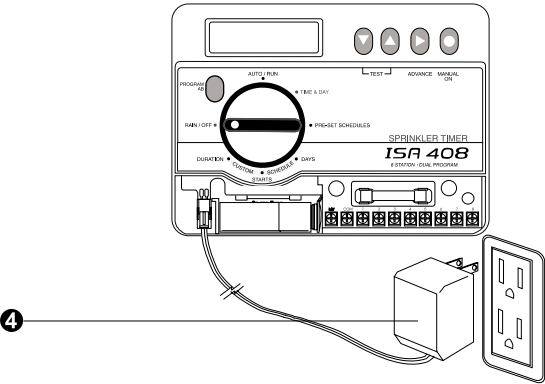

PROGRAM TIMER

Programming is the process of telling the timer when and how long you want to water. The timer opens and closes the irrigation valves according to the program you set.

Each program contains:

- **Watering days** — the specific days of the week on which watering takes place (for example, Monday, Wednesday, and Friday for a “Custom” schedule), or a watering interval (for example, every third day).
- **Start time** — the time(s) of day that the program begins. This is the time that the first station in the program begins watering; all other stations then follow in sequence.

- **Watering duration (run time)** — the number of minutes that each station runs.

When programming, you can only change the field that is flashing in the LCD display. If you want to change something that is not flashing, press ► until the desired field flashes. Then change it by pressing the ▼ or ▲ buttons.



NOTE: For normal timer operation, turn the dial to the **AUTO / RUN** position. If the dial is left in any other position, schedules will not water as programmed.

Set Current Time and Day

You must set the current time and day the first time you program the timer, and after any power interruption.

- ❶ Turn the dial to **TIME & DAY**. The hour and minute digits flash in the display.
- ❷ Press ► and the day of the week will flash.
- ❸ Press ▼ or ▲ until the correct day of the week appears in the display.
- ❹ Press ► and the hour will flash.
- ❺ Press ▼ or ▲ until the current hour appears in the display.
- ❻ Make sure the correct AM / PM time indicator appears in the right-hand side of the display.
- ❼ Press ► and the minute digits will flash.
- ❽ Press ▼ or ▲ until the current minute appears in the display.
- ❾ The display should now show the correct time and day.

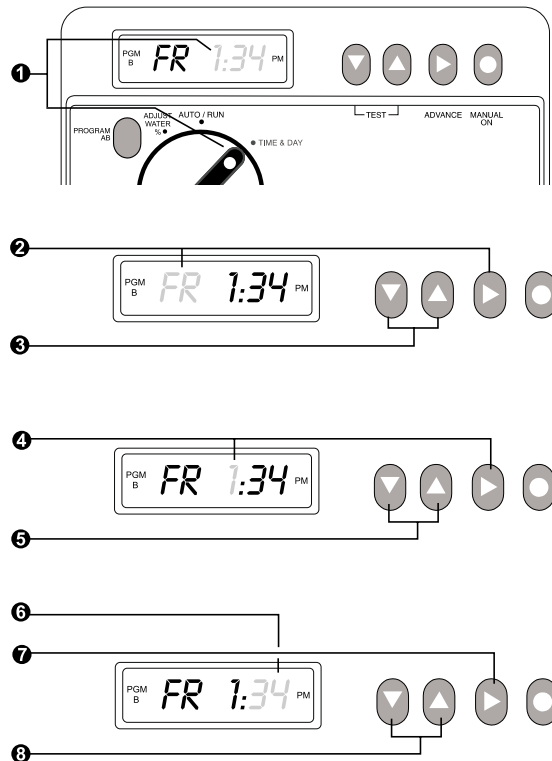

Select a Program

(ISA Models 406 & 408 Only)

ISA Timer models 406 and 408 have two programs, A and B. Each program can have its own watering schedule and start times. For example, Program A could run on Monday, Wednesday, and Friday, while Program B could run on Tuesday, Thursday, and Saturday.

You can assign any station to Program A, Program B, or both. If you only plan to use one program, use Program A.

- ❶ The currently selected program appears in the left-hand side of the LCD display. The display will show either “PGM A” or “PGM B.”
- ❷ To select a program, press the Program A/B button until the program you want appears in the display. Pressing the Program A/B button switches back and forth between the two programs.

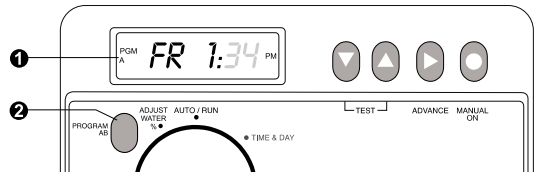

NOTE: It is easier to select one program (A or B) and program it completely before moving to the second program.

Pre-Set Watering Schedules

For your convenience, the ISA Sprinkler Timer has six pre-set watering schedules (“C” and 1 – 5). The pre-set schedules are already programmed into the timer and are shown in the table to the right.

The watering schedule you choose determines:

- What days watering occurs
- What time(s) watering starts (up to three different start times per day)
- How long the sprinklers on each station run (duration)

Once you’ve selected a pre-set schedule, you can either use that schedule’s default watering days and times, or modify the schedule to suit your own watering needs.



NOTE: Even if you want to create your own “Custom” watering schedule, you must select one of the pre-set schedules first. Then modify it to fit your needs.

Schedule	Watering Days	Start Times	Watering Duration
C	Every day	8:00 am	10 minutes
1	Every day	8:00 am	10 minutes
2	Every day	6:00 am, 10:00 am, & 2:00 pm	5 minutes
3	Every other day	6:00 am	10 minutes
4	Every third day	6:00 am	10 minutes
5	Every fourth day	6:00 am	15 minutes

If you want to water on specific days of the week (e.g., Monday, Wednesday, and Friday), select pre-set schedule “C.”

If you want to water on a fixed interval (e.g., every day, every third day, etc.), select a pre-set schedule, 1 through 5.

Select a Pre-Set Schedule

- ❶ Turn the dial to **PRE-SET SCHEDULES**.
- ❷ “C” flashes in the display.
- ❸ Press ▼ or ▲ to display the pre-set schedule you want.
- ❹ When the schedule you want appears, press ● to select it.
- ❺ The schedule number flashes, and a box appears around “SCHED” in the display. This shows that you have “locked-in” the schedule. The display also shows the watering days and the schedule’s first start time.

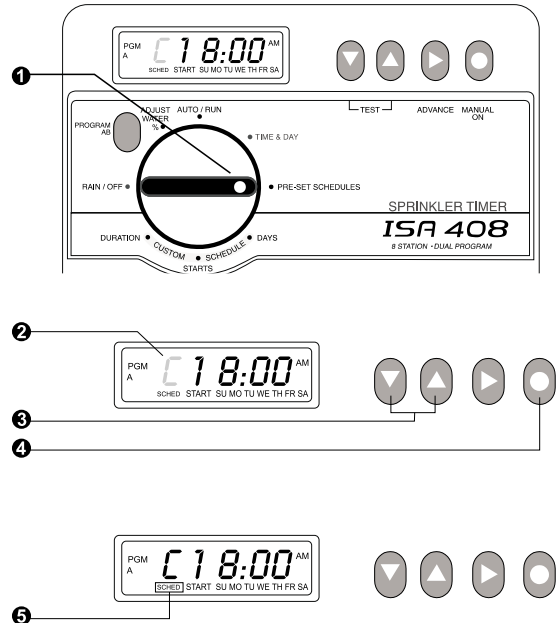

- ⑥ If you want the pre-set schedule you selected to water on its default days and time(s), just turn the dial to **AUTO / RUN** to run the schedule automatically.

Now that you've chosen a pre-set schedule, no other programming is necessary. One of the pre-set schedules will meet most homeowner's watering needs. However, if you want to modify the schedule, continue on to "Modify a Pre-Set Schedule."



NOTE: For dual-program models (ISA 406 and 408), you can select a schedule for Program B.

Press the Program A/B button until Program B appears in the display. Then repeat steps 3 – 5 to lock in a pre-set schedule for Program B.



Modify a Pre-Set Schedule

To modify a Pre-Set Schedule, you must first “select” it as described on page 17. You can then modify the:

- Watering day(s) (if you chose Custom C)
- Watering interval (if you chose Pre-Set Schedule 1 – 5)
- Start time
- Station watering duration

You must also set the schedule’s start time(s), and set each station’s watering duration. Follow the procedures below to modify the Pre-Set Schedule you selected.

Set Schedule Watering Days or Watering Interval

If You Chose Pre-Set Schedule “C:”

- 1 Turn the dial to **CUSTOM SCHEDULE — DAYS**.
- 2 The days of the week appear at the bottom of the display with “SU” (Sunday) flashing. Press ▼ or ▲ to turn watering OFF or ON for that day.

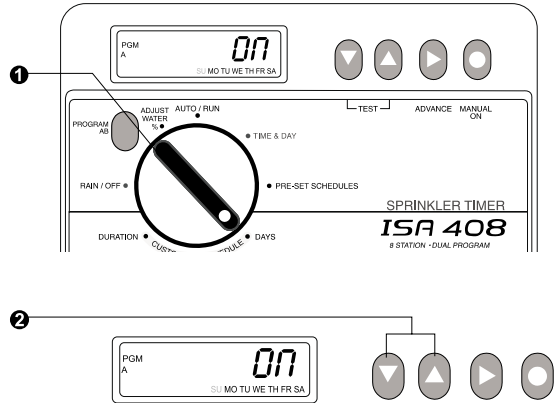

- 3 Press ▶ to move to the next day of the week.
- 4 Press ▼ or ▲ to turn watering OFF or ON for that day. Repeat Steps 3 and 4 for each day of the week. The bottom of the display will show all ON days only.

If You Chose Pre-Set Schedule 1 through 5:

- 1 Turn the dial to **CUSTOM SCHEDULE — DAYS**.
- 2 The selected pre-set watering schedule (1 – 5) flashes at the top of the display. For example, if you locked in Pre-Set Schedule 1, “Every 1 Days” would be flashing.
- 3 Press ▼ or ▲ to select the watering interval you want. You can choose any interval from “Every 1 Day” to “Every 7 Days.”

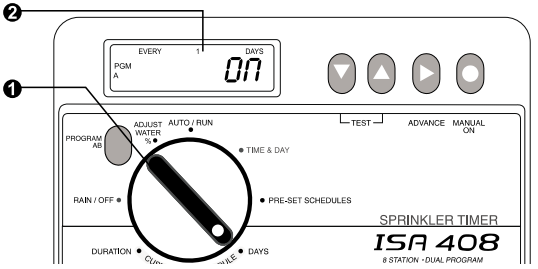

Set Schedule Start Time(s)

- ① Turn the dial to **CUSTOM SCHEDULE — STARTS**. Start time 1 flashes in the display.

You can program up to three start times per day. You can program all three start times, or leave one or two of them turned off. At least one start time must be activated for the system to water.



NOTE: Do not confuse start time numbers with station numbers. When you are setting start times, the word “Start” appears in the bottom of the display.

If you set up more than one start time for a program, the program will run several times a day — even if the start times are all the same. For example, if you enter three 8:00 a.m. start times, the program will run three times, starting at 8:00 in the morning.

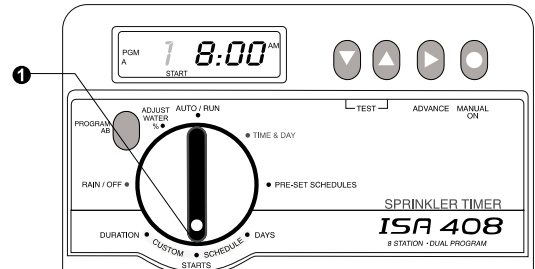

- 2 Press ► and the time of start 1 flashes.
- 3 Press ▼ or ▲ to set the start time you want. You can set start times in increments of 15 minutes. To turn off a start time, advance the time past 11:45 p.m. (The OFF position is between 11:45 p.m. and 12:00 a.m.)
- 4 To set additional start times, press ► and start 1 will flash again.
- 5 Press ▲ to advance to start 2.
- 6 Repeat steps 2 through 6 to set start times 2 and 3, if necessary.

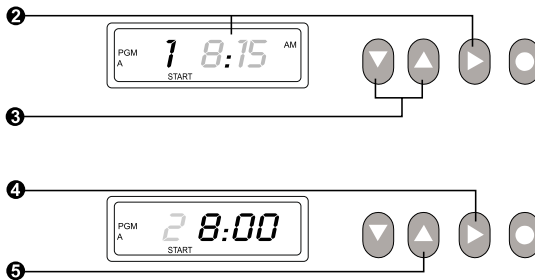

Set Station Watering Duration (Run Times)

- 1 Turn the dial to **CUSTOM SCHEDULE — DURATION**. Station 1 flashes and its watering duration appears in the right side of the display.

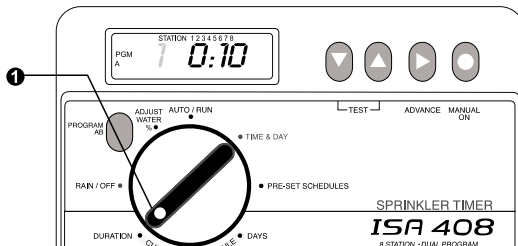

- 2 To change the watering duration of any station, press ▼ or ▲ until the desired station number flashes in the display.
- 3 Then press ►. The watering duration minutes flash. You can set each station for a different watering duration from 1 minute to 2 hours.
- 4 Press ▼ or ▲ to set the length of time you want the station to water. To turn off the station, press ▼ to move past :01 minutes until OFF appears in the display. The OFF position is between :01 minutes and 2:00 hours.
- 5 Press ► and repeat steps 2 – 5 for each station. This completes the programming for a custom schedule.
- 6 Turn the dial to **AUTO / RUN** to resume normal operation.



NOTE: For dual program models (ISA 406 and 408), press the Program A/B button to switch programs. Then repeat all programming steps for the second program.

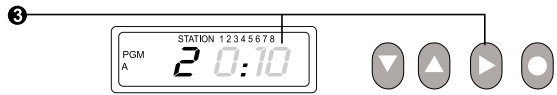

View Pre-Set Schedule Information

If you wish, you can use this procedure to view the default watering information for any Pre-Set Schedule. The same information is shown in the table on page 16.



NOTE: You cannot modify any schedule information displayed during this step. This procedure only lets you view the schedule information.

- 1 Turn the dial to **PRE-SET SCHEDULES**.
- 2 Press ▼ or ▲ until the display shows the schedule you want to view.
- 3 Press ►. Start time 1 flashes and the display shows the time set for start #1.
- 4 Press ▲. Start time 2 flashes and the display shows the start time for start #2. Repeat to view start #3.

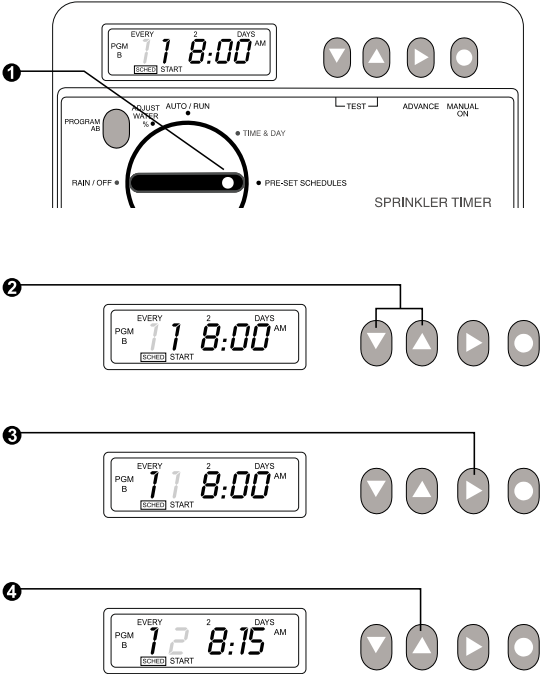

- 5 Press ▶. Station 1 flashes and the display shows the watering duration set for Station 1.
- 6 Press ▲. Station 2 flashes and the display shows the watering duration for Station 2. Repeat to view additional stations.
- 7 Press ▶. The display shows the schedule number and watering frequency (for example, “Every 2 Days”).
- 8 Repeat steps 2 through 7 to review additional schedules.



OPERATING THE TIMER

Turn the Timer On and Off

- 1 To set the timer to automatic operation, turn the dial to **AUTO / RUN**. The display will show the current day and time, and all Pre-Set and Custom schedules will water automatically.



NOTE: The dial must be in the **AUTO / RUN** position to water automatically. If the dial is in any other position, your watering schedule(s) will NOT run.

- 2 To turn off the timer and prevent all watering, turn the dial to **RAIN / OFF**. The display will show the current day and time and will alternately flash "OFF" to show you the timer has been turned off.

You may want to turn the timer off during rainy weather, system maintenance, seasonal shutdown, or any time you don't want watering programs to run as scheduled.

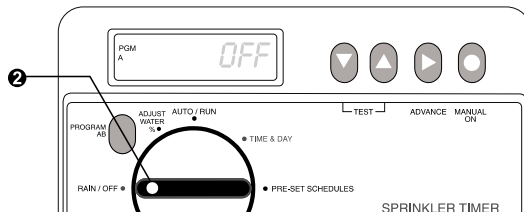
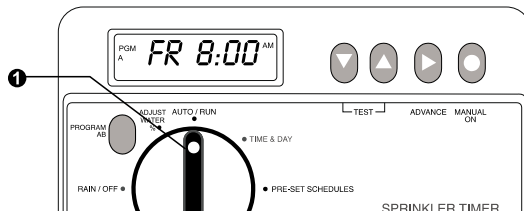

Run a System Test

The ISA Sprinkler Timer has a built-in test program that will run each station in sequence for two minutes. You can use this program to test the proper operation of the system's valves and sprinklers.

- ❶ Turn the dial to **RAIN / OFF**.
- ❷ Press and release the ▼ and ▲ buttons at the same time. The stations will turn on, one at a time, in sequence (except those you have programmed OFF), starting with station 1.

The display will show the station number, the remaining run time, and will alternately flash "OFF" as the test run time counts down.



NOTE: To cancel the test program after it has started, press the Manual On ● button repeatedly until you cycle through all the stations and the LCD shows the current day and time.

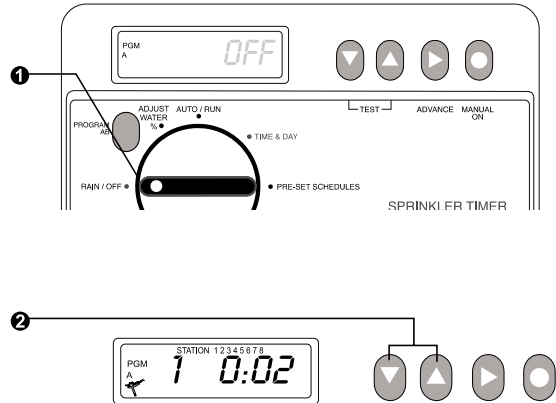



NOTE: The “Sprinklers On” symbol  will appear in the display whenever the system is watering (i.e., during normal operation, manual operation, or a test program).

3 If you have a dual-program timer (ISA Model 406 or 408), only the stations assigned to program A or B (whichever appears in the display) will run during the test.

To test the other program, press the Program A/B button. Then repeat step 2.

4 When the test is finished, turn the dial back to **AUTO / RUN**. Remember, the dial must be on **AUTO / RUN** to water normally.

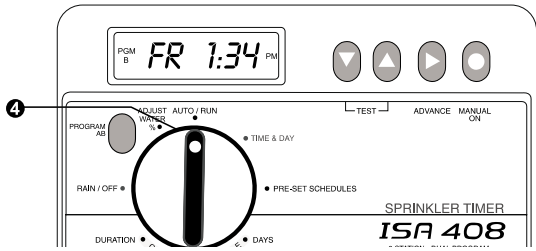
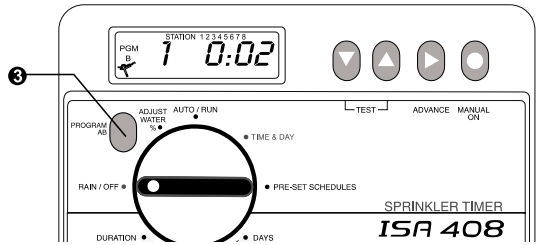

Manually Run a Program or Single Station

If an area needs extra watering, you can manually run individual stations or an entire program. Follow the appropriate procedure for manual operation.



NOTE: You cannot operate the timer manually during regularly scheduled watering times, or when the dial is in the **RAIN / OFF** position.

Run Program(s) Manually

- ❶ Turn the dial to **AUTO / RUN**.
- ❷ Press the ● button once. The stations will turn on, one at a time, in sequence (except those you have programmed OFF), starting with station 1. Each station will run for its programmed watering duration.



NOTE: To stop manual operation after it has started, turn the dial to **RAIN / OFF** for five seconds. When the “Sprinklers On” symbol  disappears from the display, manual watering will stop. Then turn the dial to **AUTO / RUN** to resume normal operation.

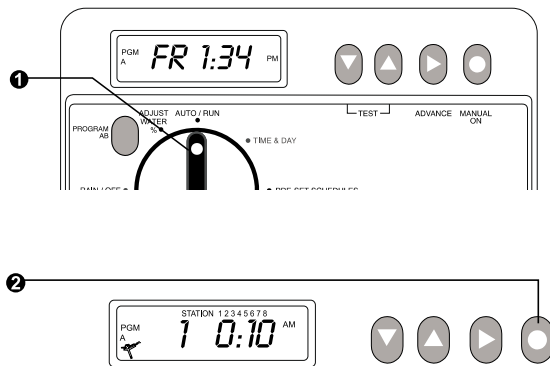

- 3 For dual program models (ISA 406 and 408), manual operation will run the program (A or B) that appears in the left-hand side of the LCD.

To switch programs, press the Program A/B button until the desired program appears in the LCD. Then press ● to begin watering.

Run Station(s) Manually

- 1 Turn the dial to **AUTO / RUN**.
- 2 Press the ► button. Station number 1 flashes in the display.
- 3 If you want the displayed station to water, press the ● button.
- 4 Press ▲ to advance to the next station. Repeat steps 2 through 4 to select all the stations you want to run.

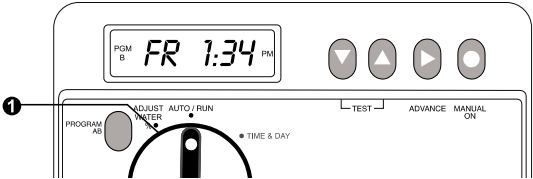
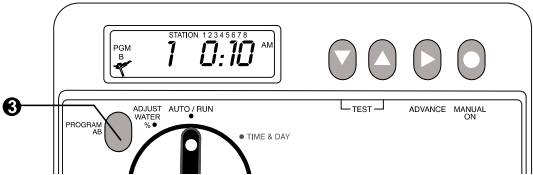



NOTE: To stop a manual cycle after it has started, turn the dial to **RAIN / OFF** for five seconds. When the “Sprinklers On” symbol  disappears from the display, manual watering will stop. Then turn the dial to **AUTO / RUN** to resume normal operation.

- 5 The first selected station will begin watering immediately. When you finish selecting the station(s) you want to water, those station numbers will flash in the top of the display.

After 15 seconds, the stations remaining in the top of the display will water. Each station will run for its normally programmed watering time.

- 6 For dual program timers (ISA model 406 and 408), manual operation will only run the station(s) on the program (A or B) shown in the left side of the LCD.

To switch programs, press the Program A/B button until the desired program appears in the display. Then repeat steps 2 through 4 to manually start the desired stations in that program.

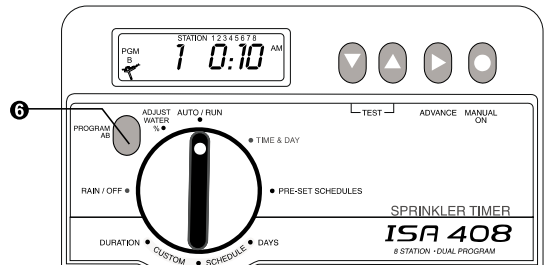

Adjust Watering Percentage

The Watering Percentage feature (sometimes called “Water Budgeting”) lets you increase or decrease the watering duration (run times) of all stations on both programs (A and B), without reprogramming the timer.

You can set the watering percentage from 10% to 200%, in 10-percent increments.

Use the Watering Percentage feature to cut back watering during cool winter months, or to increase watering during hot, dry weather.

Watering percentages are calculated on the normal programmed run times for each station. For example, if a station normally runs for 10 minutes, and you set the Watering Percentage to 80%, the station will water for 8 minutes (80% of 10 minutes).

If you set the Watering Percentage to 120%, that same station will water for 12 minutes (120% of 10 minutes).

- 1 Turn the dial to **Adjust Water %**. The selected program (A or B) and the currently selected Watering Percentage appear in the display.

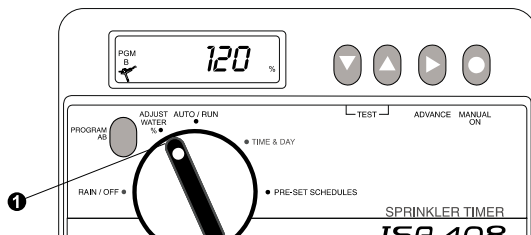

- Press the ▼ or ▲ buttons to select the desired Watering Percentage.
- Turn the dial back to the **AUTO / RUN** position. All stations will now run at the selected Watering Percentage.

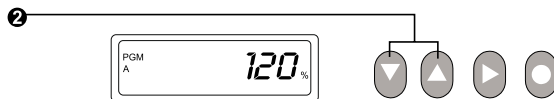

WINTERIZING THE SYSTEM

In cold-weather areas, you may want to turn off your timer during winter months. Before shutting down the system for the winter, make sure to drain the water from all irrigation lines to prevent freezing damage to pipes and valves.

Then turn the dial on the timer to the RAIN /)OFF position.

For more information about “winterizing” your system, please call your local irrigation professional, visit our Web site at www.rainbird.com, or call 800-RAINBIRD.

In lightning-prone areas, Rain Bird recommends that you disconnect the field wires from the timer's terminal strip, and unplug the transformer from the outlet. This will protect the timer from lightning-caused power surges.

TROUBLESHOOTING

Symptom	Cause	Correction
Electrical Issues		
1. LCD display is blank, or flashes "AC OFF," and the time.	a. Burned out fuse	Replace the fuse with the timer's spare fuse (750mA for 406 and 408; 500mA for 304).
	b. Transformer not plugged in	Make sure the two-prong connector is connected and the transformer is securely plugged in.
	c. Wall socket not supplying power	Make sure the main AC power supply is working properly.
2. Fuse blows out frequently and the display goes blank.	a. Wiring short between the valve and the timer	Check all field wiring for nicked or "skinned" wires. Check all wiring connectors. Repair or replace as needed.
	b. Shorted solenoid on one or more valves	Check all valve solenoids for proper operation. Replace as needed.

Symptom	Cause	Correction
Electrical Issues		
3. Fuse blows as soon as the timer is plugged in.	a. Faulty transformer	Replace the transformer.
	b. Electrical short in the timer	Call the Rain Bird Technical Assistance Hotline at 800-247-3782.
4. LCD display is “frozen,” and the timer will not accept programming.	An electrical surge may have damaged the timer’s electronics.	Unplug the timer and remove the battery and fuse. Let the timer sit for three minutes without power. Then reinstall the battery and fuse, and plug in the timer. If there is no permanent damage, the timer will accept programming and resume normal operation.

Symptom	Cause	Correction
----------------	--------------	-------------------

Watering Issues

5. Automatic and Manual cycles do not begin watering.	a. Water source not supplying water	Make sure the main water line and all supply lines are open and operating properly.
	b. Wires not properly connected	Make sure all field wires and master valve/pump start relay wiring is connected properly.
	c. Wires loose or cut; corroded connections	Check field wiring for broken, cut, or "skinned" wires. Replace if necessary. Check all wire connections and replace with watertight splice connectors, as needed.
	d. Dial not set to AUTO / RUN	Make sure the dial is on AUTO / RUN, not any other dial position.
	e. All stations set to OFF (zero run time programmed)	Check all stations' watering duration. Make sure each station is programmed with a non-zero watering time.

Symptom	Cause	Correction
Watering Issues		
6. Watering occurs at the wrong start times on AUTO / RUN.	The wrong pre-set schedule may be “locked in”	Turn the dial to Pre-Set Schedules and make sure you have selected the correct schedule. If you have a dual-program timer (ISA 406 or 408), the station(s) may be programmed to run on both programs (A and B). Check the start times for both programs.
7. Watering does not start properly during manual operation	Wrong program may be selected.	Press the Program A/B button until the program (A or B) you want to water appears in the display.
8. Valve does not shut off after watering at the scheduled time.	<p>a. Valve may be clogged.</p> <hr/> <p>b. Timer’s memory board is “locked on”</p>	<p>Inspect the valve and remove any debris.</p> <hr/> <p>Same as correction for Step 4.</p>

Symptom	Cause	Correction
Watering Issues		
9. A single station does not shut off after watering.	Valve may be stuck open due to debris	Inspect the valve and remove any debris.
10. Timer Test Mode does not work	Dial in the wrong position	Make sure the dial is in the RAIN / OFF position before pressing the ▲ and ▼ buttons.

NOTES

NOTES

NOTES

NOTE: This irrigation timer generates radio frequency energy and may cause interference to radio and television reception. It has been type tested and found to comply with the limits for a Class B computing device in accordance with the specifications in Subpart J of Part 15 of FCC Rules, which are designed to provide reasonable protection against such interference in a residential installation.

However, there is no guarantee that interference will not occur in a particular installation. If this equipment does cause interference to radio or television reception, which can be determined by turning the equipment off and on, the user is encouraged to try to correct the interference by one or more of the following measures:

- reorient the receiving antenna
- move the timer away from the receiver
- plug the timer into a different outlet so the timer and receiver are on different branch circuits.

If necessary, the user should consult the dealer or an experienced radio and television technician for additional suggestions. The user may find the following booklet prepared by the Federal Communications Commission helpful: How To Identify and Resolve Radio-TV Interference Problems. This booklet is available from the US Government Printing Office, Washington D.C. 20402, Stock No. 004-000-0034504. (Price is \$2.00 postpaid.)

Rain Bird Corporation Customer Support Center
1-800-RAIN-BIRD
(520) 434-6290 FAX
www.rainbird.com

© 2001 Rain Bird Sprinkler Mfg. Corp.